

Fuel Injection Technology

MOTORCYCLE

Fuel Injection Technology

OWNER'S 50 MANUAL

MOTORCYCLE

Dear Customer:

Thank you for purchasing the scooter.

The scooter is a product manufactured by using advanced equipment and made up of high-quality component parts. Equipped with electronic igniter ,electric starting motor and protection-welded frame, the vehicle features high performance , good fuel economy,low noise level , quick acceleration and good mobility .All these features combine to make the scooter a high-rating vehicle for us in urban areas as well as a trendy symbol of the modern world.This manual provides detailed information about the correct operation, maintenace and adjustment of your vehicle and following these tips can make your unit durable.

The manufacturer hereby beg your understanding in case of any inconsistence between the content (pictures or verbal descriptions) of this manual and the actual condition of your vehicle due to possible changes in the specifications.

Please read this manual carefully to ensure safty and maximum ease of use .We remain wishing you all the best with your vehicle.

Important Notice:**● Driver and passenger**

This vehicle is designed to carry only one driver and one passenger . Do not exceed the rated load capacity specified on the specification label.

● Road condition

This vehicle is designed to travel on flat road.

●Read this manual carefully to get a good understanding of the information contained there in.**●Pay special attention to sentences or paragraphs under the following headings:****WARNING:**

This heading warns you that serious personal injury or death may result if fail to operate as instructed in the manual.

CAUTION:

This heading reminds you that personal injury or mechanical damage may result if you fail to operate as instructed in the manual.

NOTE:

This heading is used to precede instructions on effective operation .

You should regard this manual as a permanent component part of your vehicle, perform periodic maintenance of your vehicle in a proper way . It is suggested to have your new vehicle inspected and maintained one month after purchase or after 300 km of driving usage and the best place to have this done is in nearby service center authorized by the manufacturer.

Safety Precautions

It is only the driver that can ensure the safety of travel.

A safety-minded motorbike driver always spend much time learning how to drive and develop his driving skills in a place where traffic is not so busy beforehe begins to drive on a highway road.

1. A great many of motorbike accidents were caused by the failure of the car driver to see the motorbike driver. Therefore, the motorbike driver should use every means to make himself clearly seen by the car driver. He can do this, for example, by:

- Wearing colorful and eye-catching clothes, and
- Avoiding the blind spot to traffic and driving without any mental alertness.

2. Many motorbike accidents happened at the intersection of roads, entrance to a parking lot and on a carriage way. Therefore be extremely care for when driving through these areas.

3. High-speed driving is a major cause for motorbike accidents. Always observe the speed limit and never drive in excess of it.

Many motorbike accidents were caused by inexperienced drivers. Those who have just learnt how to drive a motorbike should be thoroughly.

4. familiarized with the performance of the vehicle before driving on a highway road. Never lend your vehicle to anyone who is inexperienced in driving.

5. As most of serious motorbike accidents caused injuries of the drivers in head, it's suggested to wear a helmet and protective fits such as protective glasses, boots, gloves, thick and strong coat. .

6. Avoid driving on an expressway. If this is unavoidable, you must be very careful to ensure safety.

7. Do not drive on toughly rugged road as rough surface may lead to loss of control and cause damage to the vehicle structure.

Safety Rules

1. Before driving a motorbike, be sure to check it carefully (See the section "Inspection before Operation" of this manual).

2. Always put on a helmet and if possible wear boots, gloves, eye-protecting glasses and colorful clothes to ensure safety.

3. The rear luggage rack or trunk box installed by the driver is used to carry lightweight objects only. If a trunk box is attached to either rear side of the vehicle, the objects should be equally distributed inside either trunk box. The objects being carried should be securely fastened in place so that they will not move during travel. See the relevant part of the manual for detailed information on loading.

4. When driving, hold the handlebar with both hands and put feet on the footrest.

5. Before driving on a highway road, you should practice on a place free of busy traffic to familiarize yourself fully with the performance of your vehicle.

6. Always remember to switch on the turn signal lights before making a turn or change lines.

7. Do not drive your vehicle on the shoulder on either side of the road. You should always remember not to cause damage to the natural beauty and public facilities.

WARNING:

- A) The trunk box is used to carry only lightweight objects, not for very heavy ones.
- B) When determining if the vehicle is overloaded (the rated load capacity being 150 kg) , the weights of the objects being carried , the vehicle and the driver should be put together .
- C) An overloaded vehicle is unable to run steadily and becomes difficult to operate.



Meter Panel and Indicators

All the controls for the indicators and warning lights are located on the meter panel. Their functions are described in detail in the following pages.

- ① Left turn signal indicator
- ② Right turn signal indicator
- ③ High beam incicator
- ④ Low fuel level reminder indicator
- ⑤ Water temperature alarm indicator
- ⑥ Vehicle driving speed
- ⑦ Coolant temperature indication
- ⑧ Engine speed indication
- ⑨ Vehicle mileage

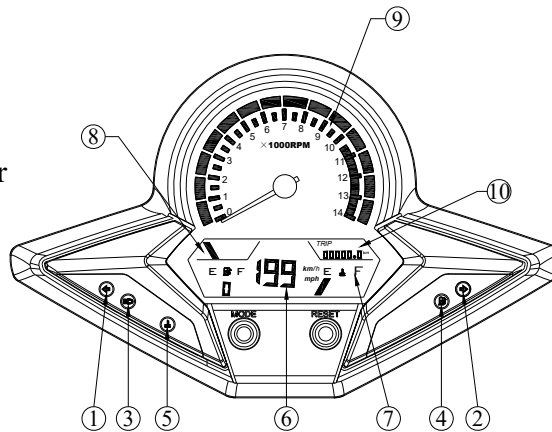

Fuel gauge

The fuel gauge indicates the approximate amount of fuel remaining in the fuel tank. When the needle pointer stays in the F(full)position, it means the total capacity of the fuel tank is now 18.0 liters (including reserve fuel). When the needle pointer approaches the first dot of the red mark, it means the fuel tank must be refilled immediately. With the needle pointer staying in the red mark.

Guide to Operation

Ignition Switch

- ① ON position Turn the switch to this position to start the engine; the switch key can not be . pulled out in this position.
- ② OFF position Turn the switch to this position to shut down the engine ;
- ③ the switch key can be pulled out in this position.

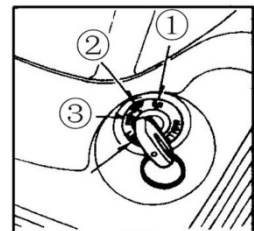

- ④ LOCK position Turn the switch all the way to the left , push it down and turn it to the LOCK position; the key can be pulled out. In this case, the vehicle can not be steered and the engine as well as the lighting system will not work.

NOTE:

In hot weather, leaving the engine idling for a long time will cause it to over-heat. You should shut it down to let it get cool.

(1)Headlight beam switch

Push the “①” button for high beam and the “②” button for low beam.

(2) “②” Turn signal light switch

Set this switch the “←” position to indicate a left turn and to the “→” position to indicate a right turn and push it down to turn off the signal lights .

(3) “③” Horn button

Push this button to make blaring sound from the horn.

(4) “⑤” Start button

When this button is pushed,the starting motor works to start the engine.

See the part“Statting the Enigne” for the starting procedure.

(5) “④” Engine idle switch

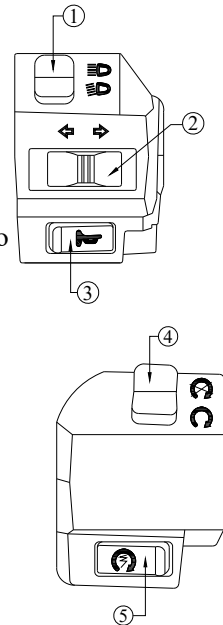

LOADING OF CARGO

NOTE:We have special requirements for the distributed weight of goods.

Improper loading affects the function and stability of the motorcycle, even causes accidents and damages the vehicle.

- 1.The article box and file box are used to carry lightweight articles.
2. Strictly forbid loading goods with excess weight on the vehicle, otherwise it may cause accidents .The following loading specification should be followed:

Max.loading capacity of article box: 10kg

Max.loading capacity of file box: 1.5kg

3. Goods are not permitted to be loaded on non-designated placed on the vehicle, otherwise the covering parts of the vehicle may be damaged.

Inspection before Operation

Before you operate the vehicle each day,be sure to check it as a routine. This job is important to keeping the vehicle in good performance and ensuring safe operation.

Fuel Level

The fuel tank has a capacity of 18.0 liters. If the fuel gauge pointer comes near to the red mark position, you should refill the fuel tank and at the same time check it for leakage.

The recommended fuel for use is 90#lead-free gasoline.

CAUTION:

● Take extreme care when refilling the fuel tank not to get dust, water or other foreign matters into the fuel tank, Do not mix the fuel with engine oil. Only gasoline can be poured into the fuel tank.

WARNING:

● Gasoline is a highly inflammable substance and will even explode under certain conditions . Therefore always do the fueling in a well ventilated place and shut down the engine. Meanwhile do not smoke or generate sparks in gas stations and places where gasoline is stored.

● Do not make the fuel tank too full (Fill it up to pipe at the refill opening without trapping any fuel in it) . Tighten the fuel tank cap after refilling.

● Gasoline is poisonous and if swallowed by mistake will cause loss of consciousness or even death . Therefore do not soak the skin in gasoline for a long time or breathe in its vapor.

Checking the oil level and refilling

1. Turn down the center stand. Remove the oil dipstick and clean it.
2. Insert the dipstick directly (without turning it) into the oil tank.
3. Remove the dipstick and check the oil level. If the oil level comes near to the lower limit mark, refill the oil tank up to the upper limit mark.

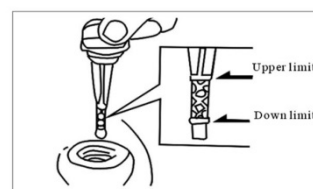

Using the recommended type of oil

SAE 10W-30(SIGMA) for 4-stroke engines or its substitute HQB-10 should be used.

CAUTION:

1. The market is full of fake oils. Using such oils may cause engine trouble.
2. To ensure safe and normal use of your vehicle, be sure to use the recommended type of oil.

Brakes

Adjusting the front brake

Check the brake for normal performance and adjust its free play. The free play refers to the distance for which the front brake lever travels freely to achieve the braking effect.

Required free play: 5 to 10mm

Adjusting the rear brake

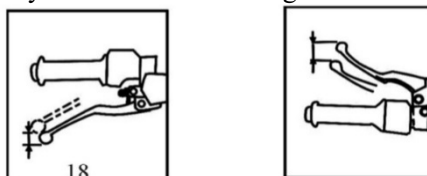

Measure the traveling distance of the rear brake lever before the brake begins to create the braking effect, which should be within 10 to 20 mm from the top end of the brake lever.

Maintaining the brakes

Replace the brake shoe and lining when it is found worn down to the limit.

NOTE: Leave the maintenance of the brakes to the authorized service center. Always replace the brake shoe with one of the same brand or another brand of the same quality.

Checking the tire pressure

Check the tires for correct inflation pressure.

Normal tire pressure

Front wheel 225 kpa

Rear wheel 225 kpa

Check the tire surface for cuts, nails or other sharp objects and the wheel rim for impressions, dents or deformations. If damage of any degree is found with the tire send your vehicle to the nearby service center for repair, replacement and adjustment of balance between the two wheels.

WARNING:

If the tire is not inflated to the specified pressure, it will wear out soon and give rise to accidents. Too low a tire pressure will cause the tire to slip or come off the wheel rim.

It is dangerous to use fissured or worn tires as this will weaken the adherence of the tire to the road surface and make operation difficult.

Replace the tire if the depth of the tread in the middle of the tire falls within the following range.

Minimum tread depth	
Front Tire	1.5mm(0.06in)
Rear Tire	2.0mm(0.08in)

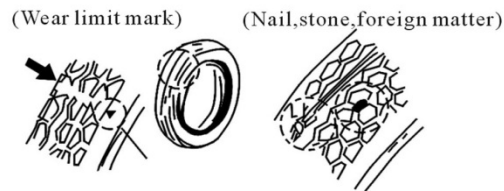

Starting the engine

Turn down the center stand to prop up the vehicle (or not to prop it up) insert the switch key into the igniter key hole and depress the rear brake pedal.

Turn the key to set the ignition switch to the ON position and, with the throttle closed, push the start button to get the engine started. If the engine fails to get started in one effort, repeat this operation several times but be sure not to keep the start button depressed for longer than 3 seconds in each attempt and an interval of about 10 seconds should be kept between two attempts. Release the button immediately when the engine is started and at the same time leave the engine running for some time to warm it up.

CAUTION:

Always start the engine with the rear brake pedal depressed.

The engine should not be allowed to run too fast when it is being warm up. Quick opening and closing of the throttle must be avoided.

Maintenance Schedule

The maintenance schedule is made according to the distance so far covered by the vehicle and tells you when to carry out the periodic maintenance and lubrication of which parts. Maintenance should take be intensified if the vehicle is used in an unfavorable for a long time. An overhauled or crashed motorbike must be sent to the authorized service to have the major parts carefully checked such as the frame, Suspension and steering mechanism to see if they are mismatched or damaged so as to ensure safe operation.

If adjustment is needed to keep the exhaust emission within the specified range. It should take place in a plant or laboratory equipped with complete test facilities.

CAUTION:

To keep the vehicle safe and reliable, do not try to modify the vehicle at will. In repair or maintenance, always replace the damaged parts with ones provided by the original manufacturer or ones of similar quality. Using other similar parts of poor quality will degrade the operability of your vehicle.

WARNING:

To ensure personal safety, be sure to shut down the engine first and place the vehicle on a flat surface and prop it up securely with the center stand before performing maintenance at whatever levels.

NOTE:

If the vehicle is to be stored for more than one month or to be used in winter, maintenance should be done in advance to prevent the fuel, tires, battery, etc, from deteriorating or rusting.

Periodic maintenance items and schedule

To ensure safety in travel, good performance and durability of the vehicle and reduce emission, be sure to perform periodic maintenance duly and properly; In the following table, I stand for inspection and cleaning, oiling, adjusting or replacing when necessary;

A for adjustment; **C** for cleaning; **R** for replacement; and **T** for tightening.

Item	Distance of travel (km)													Daily before use
	300	1000	2000	3000	4000	5000	6000	7000	8000	9000	10000	11000	12000	
Engine oil	R	R	R	R	R	R	R	R	R	R	R	R	R	I
Oil filter	C				C				C			C		
Gear oil	R			R			R			R			R	
Spark plug	Clean every 2000 km of travel and replace when necessary													
Valve gap 0.12 intake, 0.12 outtak (in cold state)		A			A				A				A	
Cam chain		A			A				A				A	
Carburetor					I				I				I	
Air cleaner	Clean filter element once per 2000 km of travel and replace every 5000 of travel.													
Battery solution	I	I	I	I	I	I	I	I	I	I	I	I	I	I
Fuel filter	Clean once every 1000 km of travel and replace when necessary.													
Brake system		I	I	I	I	I	I	I	I	I	I	I	I	I
Drive belt														
Bolts and nuts	T					T						T		
Exhaust emission	Check and adjust regularly to avoid air pollution													
<ul style="list-style-type: none"> ● The above listed items may vary according to different vehicle models. Therefore the maintenance effort should be customized to those items available on a certain model. ● Maintenance beyond the distance intervals listed in the table may be performed by analogizing the listed intervals. ● The air cleaner should be cleaned or replaced more often than specified in the table if the vehicle is used in a dusty environment. 														

Cleaning the air cleaner

A dusty air cleaner leads to an increased fuel consumption and should therefore be cleaned.

(Procedure)

1. Remove the filter sponge from the air cleaner.
2. Clean the sponge in cleaning oil and dry in the air (Do not use fuel for this purpose).
3. Clean the sponge again in engine oil and wring it dry before putting it back into the air cleaner.

CAUTION:

●In correct installation of the air cleaner will cause dust to be sucked into the cylinder and give rise to increased engine wear, reduced engine power and shortened engine life.

●Do not get the air cleaner wet when cleaning the vehicle with water or otherwise you will find the engine difficult to start. .

Engine Oil

WARNING: Be sure to refill the oil tank with engine oil (L-ERB). Immediately when the warning indicator goes on. Insufficient amount of oil will cause damage to the engine.

Check the level of the oil in the oil tank regularly .

Viscosity: The viscosity level of the engine oil to be used should suit the atmospheric temperature of the local area.

Replacing the engine oil

Replace the engine oil for the first time after 300 km of travel and then replace it once every 1,000 km of travel. Check the oil level every 500 km of travel and refill the oil tank to the specified level. The oil tank capacity is 0.6 liters.

CAUTION: Be sure to replace the oil earlier than usual if you often use the vehicle to travel on gravel roads, make frequent short trips or use it in cold areas. Unscrew the drain plug, clean the oil strainer and put it back again.

Replacing the gearbox oil (Frequency of replacement)

Replace the gearbox oil for the first time after 300 km of travel and then once every half a year or 3,000 km of travel. The #10 machine oil or GY gear oil should be used.

Gear oil capacity

Full capacity: 0.11 liters



Refill opening

Checking the spark plug

A dirty spark plug with dirty electrodes or Excessive gap between electrodes will not be able to generate full sparks.

(Cleanign)

- The best result can be achieved if you clean the spark plug with a spark plug cleaner;
- If do not have such a cleaner ,you can clean it with a wire brush.

(Adjusting the gap between electrodes)

- The side electrode gap should normally be within 0.6 to 0.7 mm (as shown in the figure)

Recommended type of spark plug for us: NGK.

NOTE: Never use other types of spark plug than the recommended one.

CAUTION:

- Aoid burning yourself when working at a hot engine just shout down.
- Screw the spark into place first by hand and tighten it with the soket wrench.

Replacing the fuse

Turn off the master switch and check the fuse to see if it is blown. Replace the blown fuse with one of the specified capacity.

- Always find out the cause before replacing a blown fuse.
- Unscrew the two screws battery and remove the battery cover .The fuse is located in the fuse box by the side of the battery.
- Open the fuse box and remove the fuse by expanding the fuse clamp from both end of the fuse.

Fuse capacity: 9A

- Always use original products of the recommended specifications when replareplacing electric components (lights , meters, etc.).
- Do not flush your vehicle with pressurized Water when cleaning it.

CAUTION:

- When removing the fuse,do not expand the fuse clamp too wide.
- After the fuse is installed , check the fuse clamp to see if it runs loose . The fuse will generate heat if the fuse clamp is loose, which is often the major cause of trouble.

WARNING:

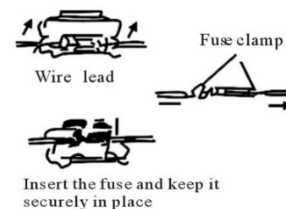
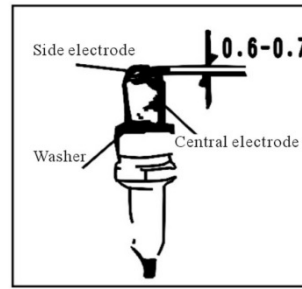

Never use a fuse having an amperage capacity different from the rated value as this will cause damage to the electric system and give rise to fire hazards or make it impossible to use the lighting system when you travel during the night or cause engine failure.

Checking the rear wheel spline and front and rear suspension fasteners

- Before checking the rear wheel spline bush, prop up the vehicle with the center stand and push the side of the rear wheel to see if you get a feeling that the rear wheel bush gets loose.
- Carefully check the fasteners for the front and rear suspension system to see they are tightened.

Checking the air cleaner

The air cleaner is fitted with a paper element which should be checked and cleaned once every 2000 km of travel. Clean the filter element in a detergent solution and dry in the air. Apply a small amount of oil to the filter element before use.

- Replace the filter element once every 5,000 km of travel. See the Maintenance Schedule for replacement.

CAUTION:

● Clean or replace the filter element more often than usual if the vehicle is used in the following situations:

- In rainy weather;
- On poor dusty road surfaces.

Adjusting the carburetor

Stable carburetion of fuel is essential to good engine performance. As the carburetor has been adjusted in factory to the best condition, do not make any change as you wish. What you can do is to adjust the throttle grip and idle speed.

(A) Adjusting the throttle grip

1. Check the throttle grip to see if it can be turned freely with the choke fully opened and fully closed when you make a right turn and left turn.
2. Check the free play of the throttle grip which, when tuned by hand, should be about 2 to 6 mm. To adjust it, loosen the lock nut and turn the adjuster.

(B) Adjusting the idle speed

1. Start the engine and allow it to run for a few minutes to warm it up.
2. Tighten the fuel supply adjuster screw and slowly loosen it by normally one and half turn. Fasten the adjuster screw at the position where the highest idle speed is obtained and then turn idle speed screw finely to the required idle speed.

Guide to proper storage of vehicle

Storing the vehicle

To store the vehicle for a long period of time such as in winter, several procedures should be used to prevent malfunction or damage of the vehicle parts during this long break .In addition, before putting your vehicle aside, some repairing efforts should also be made or otherwise you are likely forget doing such repairs when you put your vehicle back to use.

1. Replace the engine oil.
2. Drain off the remaining fuel from the fuel tank and carburetor , spray the inside of the fuel tank with a layer of anti-rust oil and tighten the fuel tank cap.

WARNING:

As gasoline is highly inflammable and may explode under certain conditions, be sure not to smoke or make sparks near it when emptying the fuel tank.

3. Remove the spark plug , pour a spoonful of engine oil into the cylinder, start the engine and run it for a few minutes to allow the oil to distribute all over the inside,and then put the spark plug back in place.

NOTE: Before turning the engine, be sure to set the ignition switch to the OFF position, put the spark plug into the cable cap and ground it to prevent damaging the ignition system.

4. Remove the battery and keep it in a place free of freezing or exposed to direct sunlight .Charge the battery once every month.
5. Clean the vehicle and dry it. Wax the painted surfaces and coat them with a layer of anti-rust oil.
6. Inflate the tires to the correct pressure .Park the vehicle by placing wood pats under both wheels to keep them off ground.
7. Put on the vehicle cover (plastic sheets or other rubber-coated materials not allowed) and store the vehicle in a cool but not damp place without great change in daily air temperature , Never expose the vehicle to direct sunlight.

What to do when putting the vehicle back to use

1. Remove the dust cover and clean the vehicle. Replace the engine oil if the vehicle has been stored for more than 4months.
2. Check the battery solution level and if necessary add battery solution. Install the battery back to the vehicle.
3. Clean the inside of the fuel tank of anti-rust oil and pour in fresh gasoline.
4. Perform all the pre-operation checks and drive the vehicle slowly in an area free from busy traffic to ensure safety.

(See also the part “Inspection before Operation”)

JJ49Q-10 Specifications

Dimension(mm) (L×W×H)	2050*800*1065	Battery capacity	12V/7ah
Axle base(mm)	1380	Ignition mode	ECU
Load-free weight(kg)	145	Spark plug	CR7HSA
Max.speed(km/h)	45	Lubrication	Separate lubrication
Max.load(kg)	75	Clutch	Dry automaticcentrifugal
Tire size	F:110/70-17 R:130/70-17	Gearshift	CVT
Wheel rim(front/rear)	F:J17XMT3.00 R:J17XMT4.00	Fuse capacity	10A
Brake(front/rear)	Disc / Disc	Driving beam	12V 12W
Rear brake operation	Hand	Passing beam	12V 6W
Engine type	JJ139FMB	Front position lamp	12V 0.6W
Work volume(ml)	49	Front direction indicator lamp	12V 10W
Starting	Electric / Kick	Rear direction indicator lamp	12V 10W
Oil capacity(L)	18±0.5	Rear group lamp	12V 2.4W / 12V 0.5W
Gear oil capacity(ml)	110	Rear registration plate lamp	12V 5W

